

# Thin-Film Low Pass Filter



## LP0603 Lead-Free LGA Type

### GENERAL DESCRIPTION

The LP0603 ITF (Integrated Thin Film) Lead-Free LGA Low Pass Filter is based on thin-film multilayer technology. The technology provides a miniature part with excellent high frequency performance and rugged construction for reliable automatic assembly.

The ITF Low Pass Filters are offered in a variety of frequency bands compatible with various types of high frequency wireless systems.

### FEATURES

- Miniature Size: 0603
- Frequency Range: 900MHz -2.4GHz
- Characteristic Impedance: 50 Ohm
- Operating/Storage Temperature: -40°C to +85°C
- Power Rating: 3W Continuous
- Low Profile
- Rugged Construction
- Lead Free
- Taped and Reeled

### APPLICATIONS

- Mobile communications
- Satellite TV receivers
- GPS
- Vehicle location systems
- Wireless LANs
- RFID

### LAND GRID ARRAY ADVANTAGES

- Inherent Low Profile
- Self Alignment during Reflow
- Excellent Solderability
- Low Parasitics
- Better Heat Dissipation

### HOW TO ORDER

LP  
T  
Style

0603  
T  
Size  
0603

A  
T  
Type  
A or N

XXXX  
T  
Frequency  
MHz

A  
T  
Sub-Type

N  
T  
Termination  
LGA  
\*\*Ni/Lead Free Solder

\*\*RoHS Compliant

TR  
T  
Taped & Reeled

### FINAL QUALITY INSPECTION

Finished parts are 100% tested for electrical parameters and visual characteristics. Each production lot is evaluated on a sample basis for:

- Static Humidity: 85°C, 85% RH, 160 hours
- Endurance: 125°C, IR, 4 hours

### TERMINATION

Nickel/Lead-Free Solder coating compatible with automatic soldering technologies: reflow, wave soldering, vapor phase and manual.



Please select correct termination style

# Thin-Film Low Pass Filter



## LP0603 Lead-Free LGA Type

### DIMENSIONS: millimeters (inches) (Bottom View)

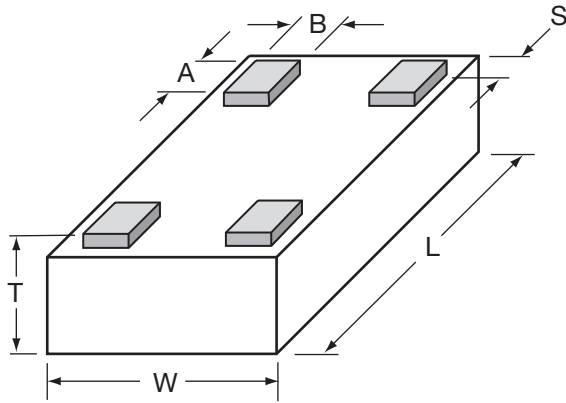

L	1.6±0.1 (0.063±0.004)	A	0.25±0.05 (0.010±0.002)
W	0.84±0.1 (0.033±0.004)	B	0.20±0.05 (0.008±0.002)
T	0.60±0.1 (0.024±0.004)	S	0.05±0.05 (0.002±0.002)

### TERMINALS AND ORIENTATION IN TAPE (Top View)

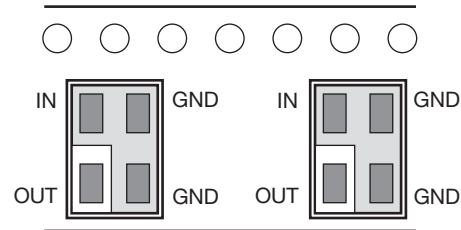

### RECOMMENDED PAD LAYOUT (mm)

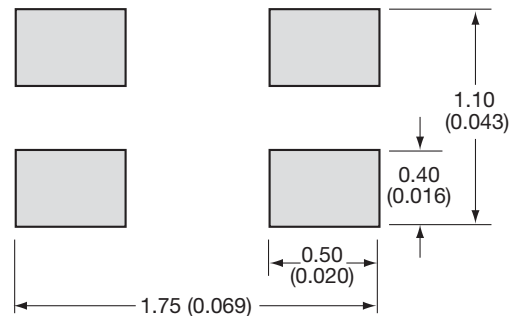

## ELECTRICAL CHARACTERISTICS

(Guaranteed over  $-40^{\circ}\text{C}$  to  $+85^{\circ}\text{C}$  Operating Temperature Range)

P/N	Frequency Band [MHz]	I. Loss [dB]	VSWR max [dB]	Attenuation typ. [dB]
LP0603A0902ANTR	890-915	0.35 typ (0.5 max)	1.4	25 @ 2xF <sub>0</sub> 14 @ 3xF <sub>0</sub>
LP0603A0947ANTR	935-960	0.35 typ (0.5 max)	1.4	25 @ 2xF <sub>0</sub> 17 @ 3xF <sub>0</sub>
LP0603A1747ANTR	1710-1785	0.3 typ (0.5 max)	1.4	25 @ 2xF <sub>0</sub> 17 @ 3xF <sub>0</sub>
LP0603A1842ANTR	1805-1880	0.3 typ (0.5 max)	1.4	27 @ 2xF <sub>0</sub> 15 @ 3xF <sub>0</sub>
LP0603A1880ANTR	1840-1920	0.3 typ (0.5 max)	1.4	25 @ 2xF <sub>0</sub> 17 @ 3xF <sub>0</sub>
LP0603A1950ANTR	1920-1980	0.3 typ (0.5 max)	1.4	27 @ 2xF <sub>0</sub> 15 @ 3xF <sub>0</sub>
LP0603A2140ANTR	2110-2170	0.3 typ (0.5 max)	1.4	27 @ 2xF <sub>0</sub> 17 @ 3xF <sub>0</sub>
LP0603A2442ANTR	2412-2472	0.3 typ (0.5 max)	1.4	25 @ 2xF <sub>0</sub> 17 @ 3xF <sub>0</sub>
LP0603N3500ANTR	3400-3600	-0.3 typ. -0.5 max.	1.4	30 @ 2xF <sub>0</sub> 20 @ 3xF <sub>0</sub>
LP0603N5200ANTR	5050-5350	-0.2 typ. -0.5 max.	1.4	30 @ 2xF <sub>0</sub> 20 @ 3xF <sub>0</sub>
LP0603N5500ANTR	5350-5650	-0.2 typ. -0.5 max.	1.4	30 @ 2xF <sub>0</sub> 20 @ 3xF <sub>0</sub>

Note: additional frequencies available upon request

# Thin-Film Low Pass Filter

## LP0603 Lead-Free LGA Type Test Jig

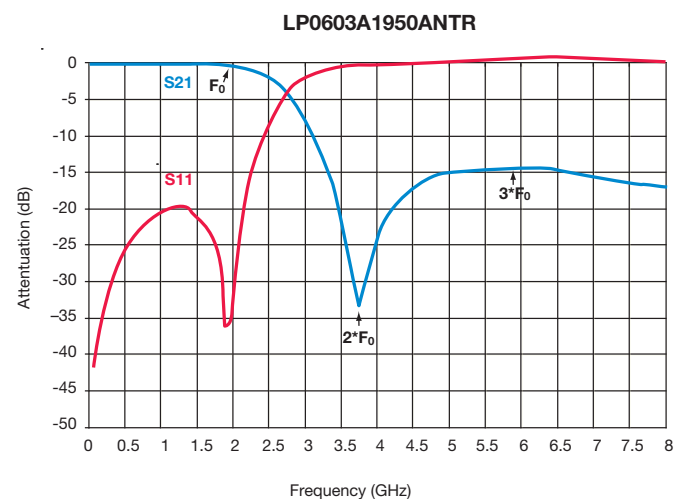
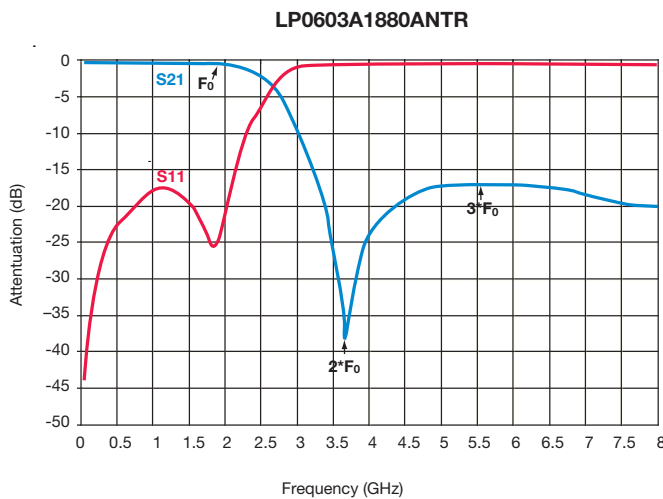
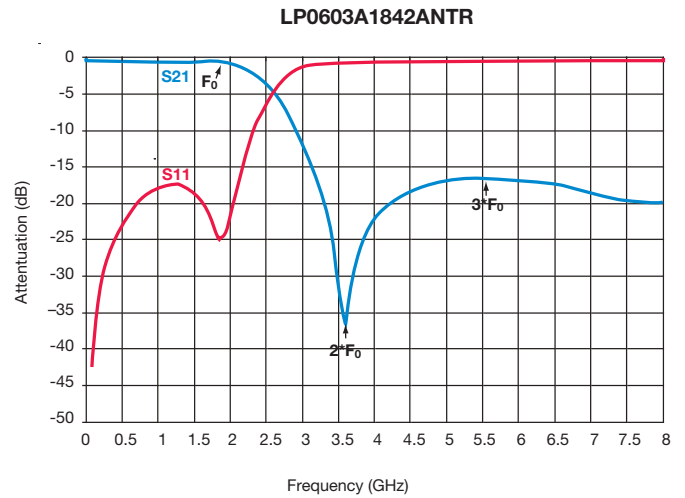
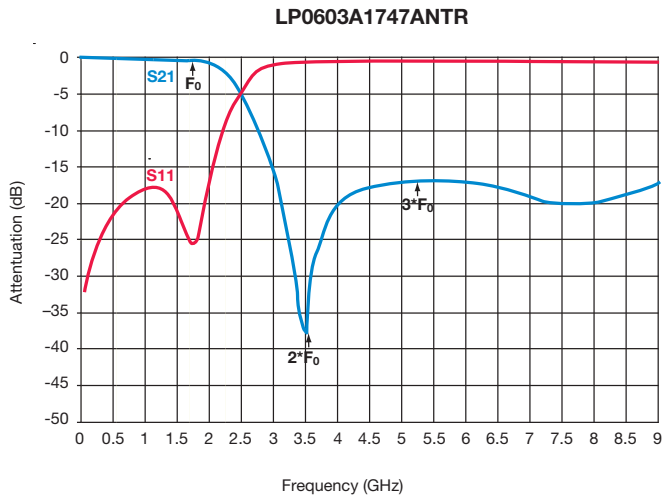
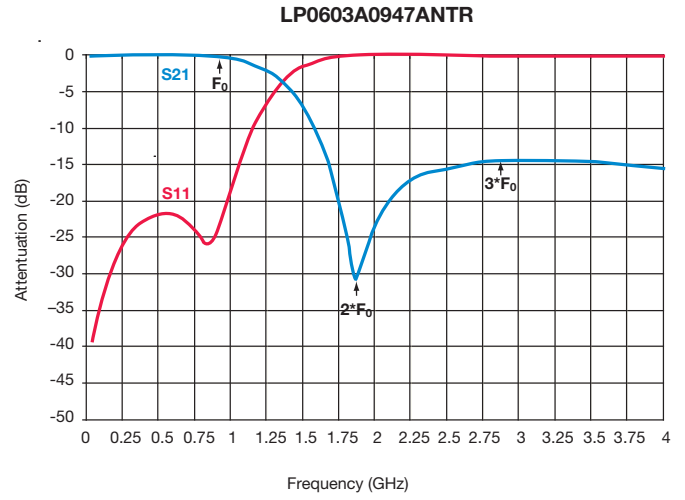
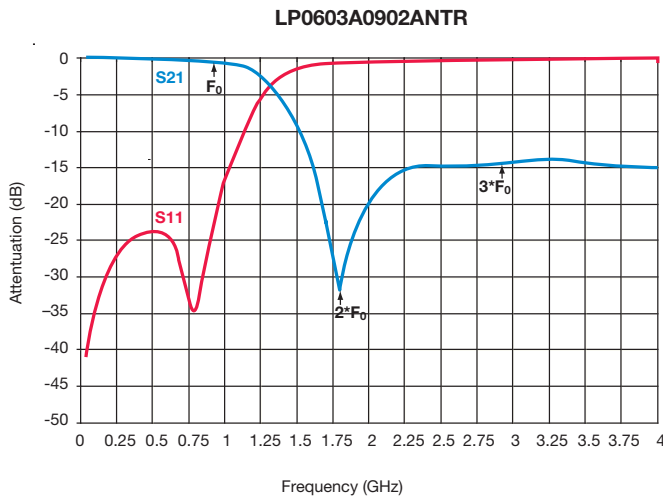

4

# Thin-Film Low Pass Filter

## LP0603 Lead-Free LGA Type Test Jig

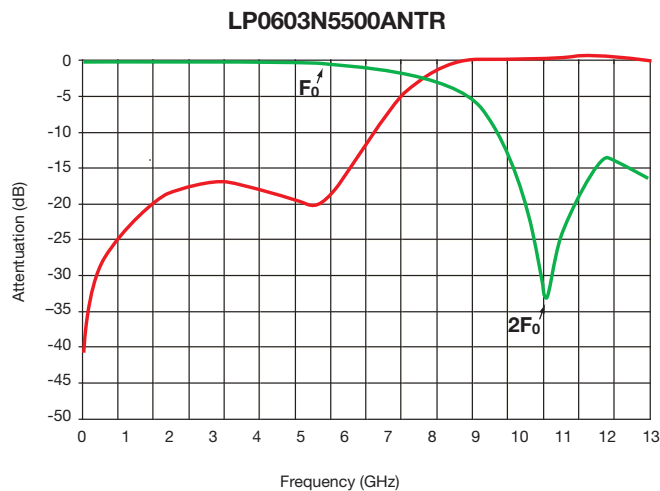
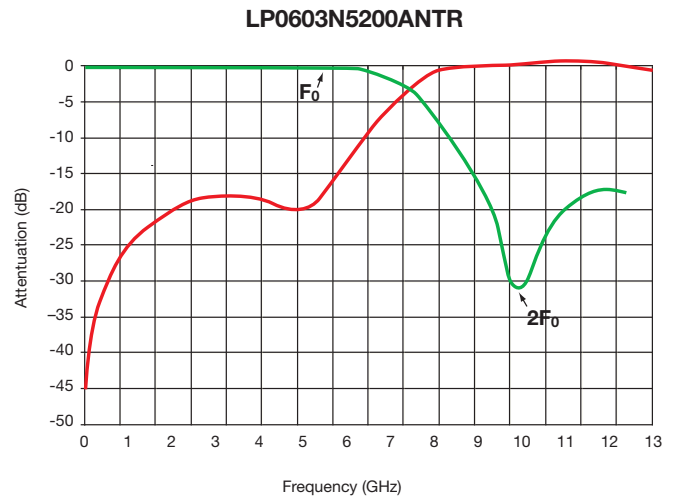
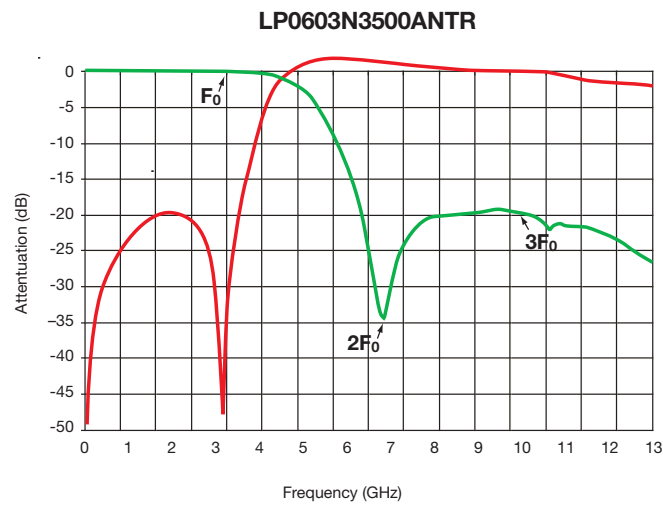
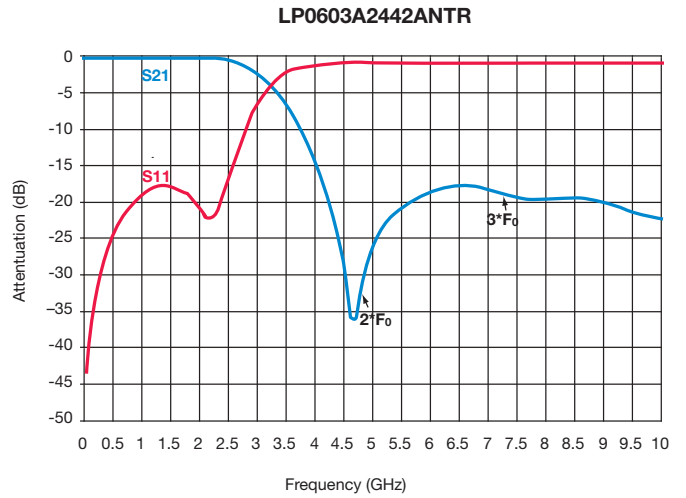
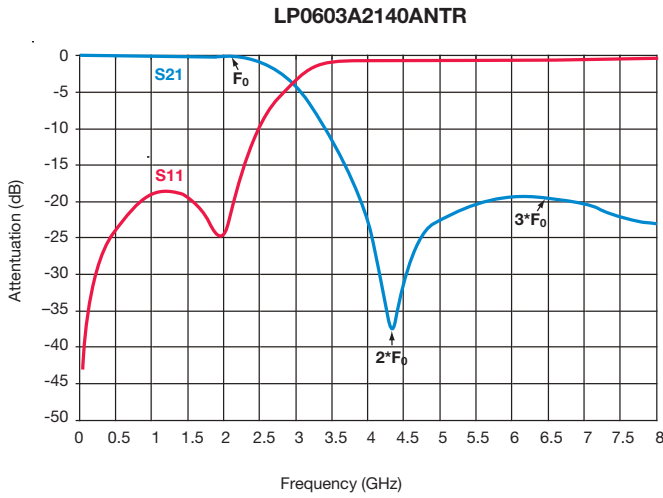

4

# Thin-Film Low Pass Filter

## LP0603 Lead-Free LGA Type Test Jig

### TEST JIG FOR LP0603 LEAD-FREE LGA LOW PASS FILTER

#### GENERAL DESCRIPTION

These jigs are designed for testing the LP0603 LGA Low Pass Filters using a Vector Network Analyzer.

They consist of a dielectric substrate, having  $50\Omega$  microstrips as conducting lines and a bottom ground plane located at a distance of 0.127mm from the microstrips.

The substrate used is Neltec's NH9338ST0127C1BC (or similar).

The connectors are SMA type (female), 'Johnson Components Inc.' Product P/N: 142-0701-841 (or similar).

Both a measurement jig and a calibration jig are provided.

The calibration jig is designed for a full 2-port calibration, and consists of an open line, short line and through line. LOAD calibration can be done by a  $50\Omega$  SMA termination.

#### MEASUREMENT PROCEDURE

Follow the VNA's instruction manual and use the [calibration jig](#) to perform a full 2-Port calibration in the required bandwidths.

Solder the filter to the [measurement jig](#) as follows:

- |                 |                     |              |             |
|-----------------|---------------------|--------------|-------------|
| Input (Filter)  | ➔ Connector 1 (Jig) | GND (Filter) | ➔ GND (Jig) |
| Output (Filter) | ➔ Connector 2 (Jig) | GND (Filter) | ➔ GND (Jig) |

Set the VNA to the relevant frequency band. Connect the VNA using a 10dB attenuator on the jig terminal connected to port 2 (using an RF cable).

**Measurement**

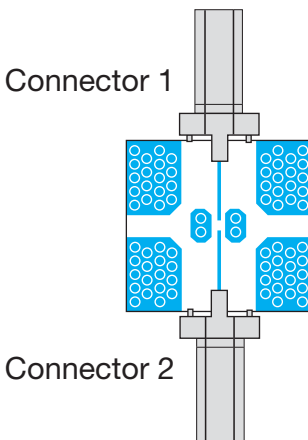

**Calibration Jig**

